

Choose Esterbrook®

Choose the right point for the way you write

Choose your holder color, size and style



Fountain pen and pencil models illustrated above, available in six attractive colors: Black, Green, Blue, Red, Gray and Brown. Pencils also available with Regular Lead (Model PJ).

THE ESTERBROOK FOUNTAIN PEN OFFERS

Point styles to fit every preference or occupational need. • Widest range of point and holder combinations at minimum inventory cost. • Selection of holders in popular sizes, styles and colors. • Permits instant replacement instead of delayed factory repairs. • Product of America's oldest pen maker.



J-P J Set—The Standard Esterbrook Combination \$5.00*

The Renew-Point fountain pen and matching push pencil in gift boxes. Colors: Black, Gray, Blue, Green, Brown and Red. Also packed with TJ Standard Thin Lead push pencil.



SM-PM Set—The De Luxe Esterbrook Combination in Attractive Gift Box \$8.00†

The Renew-Point fountain pen and mechanical push pencil with luxurious non-tarnish metal caps. Pen is equipped with double strength clip. Colors: Gray, Midnite Blue, Aqua, Maroon and Sand. Also packed with TM Thin Lead push pencil.

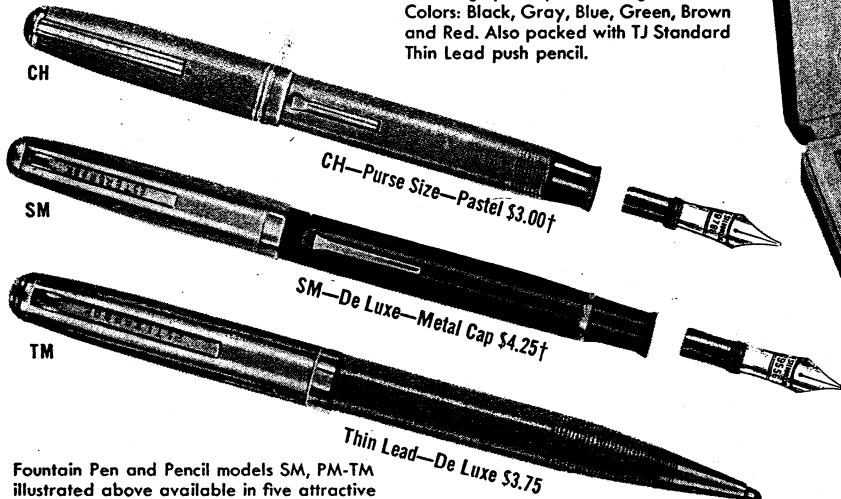

Fountain Pen and Pencil models SM, PM-TM illustrated above available in five attractive solid colors: Maroon, Aqua, Sand, Gray and Midnite Blue. Purse Pen model illustrated above, in five pastel colors: Pink, Blue, Gray, Yellow and Aqua.

*Add 50 cents per pen if Master Point is selected

Prices shown include F.E. Tax.

†Deduct 50 cents per pen if Duracrome Point is selected

Esterbrook®

WRITING INSTRUMENTS

Fast turnover, all year 'round, with America's most complete line of writing instruments.

A consistent pricing policy—to protect dealer profits.

Powerful pre-selling through national advertising and merchandising support.

Maximum sales volume with minimum investment.

Freedom from troublesome returns, complaints and exchanges.

FOUNTAIN PENS

Full range, *personal* point selection... exclusive with Esterbrook. Choice of more than 30 point styles!

Attractive styling in wide range of colors.

Well-balanced pens in variety of sizes and styles for easy, comfortable writing.

Convenient filling from any ink bottle with any good fountain pen ink.

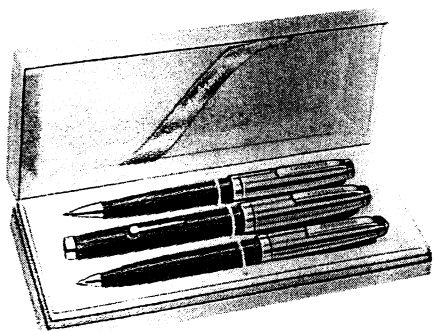

"K" THREESOME

"K" deluxe styling with gleaming, engine-turned caps. Deep-toned barrel colors: Midnight, Burgundy, Emerald Green, Royal Blue, Willow Green, Colonial Gray. Matching fountain pen, mechanical Push Pencil and Ball Point, gift boxed. \$13.50

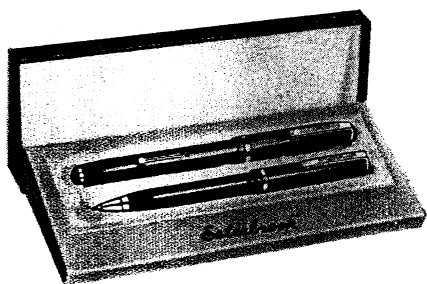

STANDARD SET

Black and five pearlescent colors: Red, Blue, Green, Gray, Brown. With matching Push Pencil or Ball Point. \$5.45

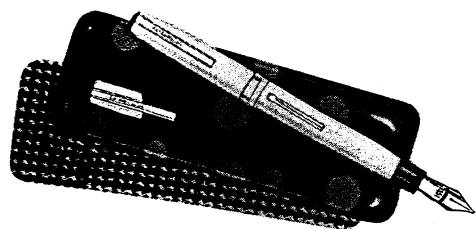

PETITE-PAK SET

Purse-size fountain pen and matching Mechanical Pencil. Colors: Aqua, Blue, Peach, Orchid, Yellow, White. Complete with attractive purse case. \$5.00



LK

"K" deluxe styling. Colors: Midnight, Burgundy, Emerald Green, Royal Blue, Willow Green, Colonial Gray. \$5.75 with Master Duracrome Renew-Point.

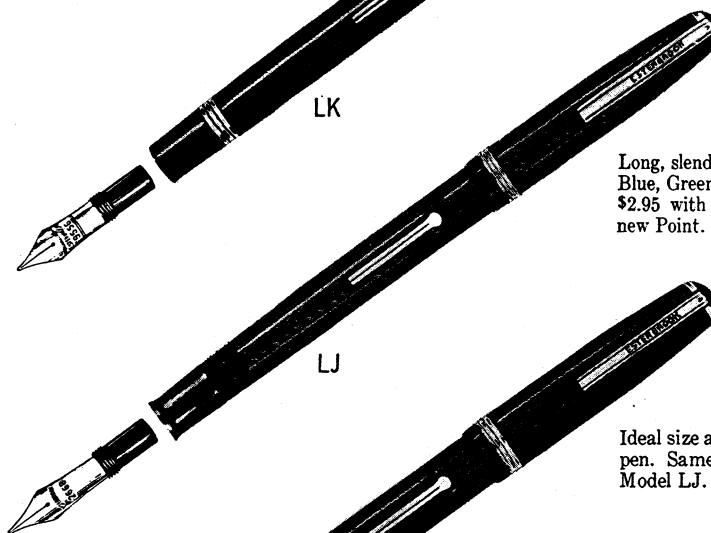

LJ

Long, slender model. Colors: Red, Blue, Green, Gray, Brown, Black. \$2.95 with Solid Duracrome Renew Point.

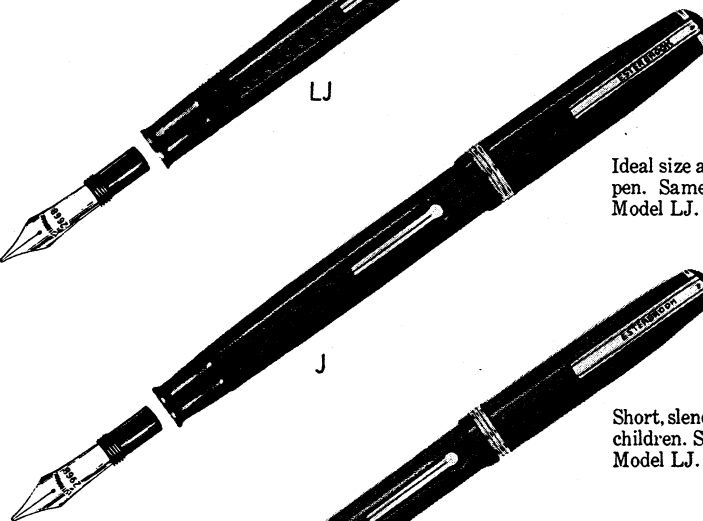

J

Ideal size and balance for a man's pen. Same colors and price as Model LJ.

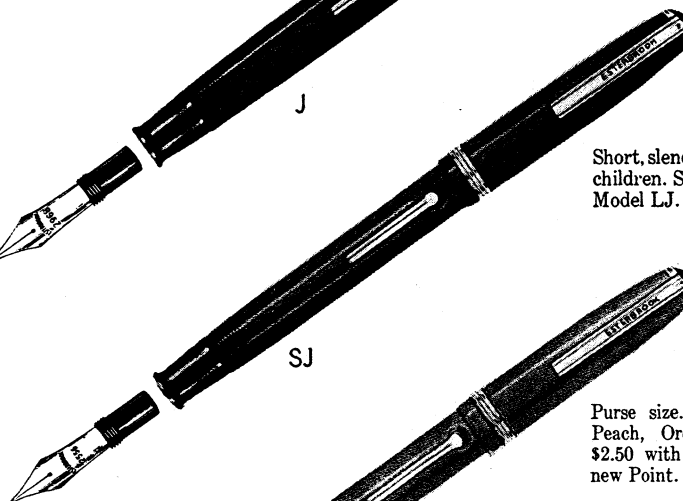

SJ

Short, slender model for ladies and children. Same colors and price as Model LJ.

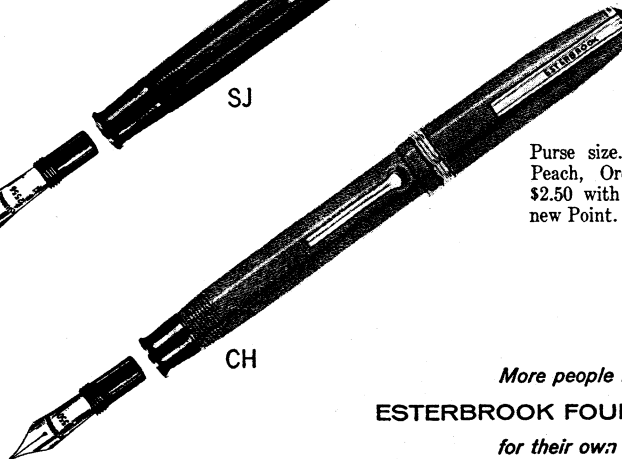

CH

Purse size. Colors: Aqua, Blue, Peach, Orchid, Yellow, White. \$2.50 with Solid Duracrome Renew Point.

More people buy
ESTERBROOK FOUNTAIN PENS
for their own use
than any other brand

RENEW-POINTS



SOLID DURACROME POINTS. *0.60 EACH

- | | |
|---------------------------------|---------------------------------|
| No. 1550 <i>Bookkeeping</i> | No. 2668 <i>General writing</i> |
| No. 2550 <i>Bookkeeping</i> | No. 1461 <i>Carbon Copies</i> |
| No. 2556 <i>Fine writing</i> | No. 2968 <i>Broad writing</i> |
| No. 2048 <i>Shaded Writing</i> | No. 2442 <i>Fine Stub</i> |
| No. 1554 <i>Clerical</i> | No. 2314F <i>Fine Stub</i> |
| No. 1555 <i>Shorthand no. 2</i> | No. 2314M <i>Medium stub</i> |
| No. 1551 <i>Student</i> | No. 2314B <i>Broad Stub</i> |

No. 2284 *Signature Stub*

MASTER DURACROME POINTS *1.15 EACH

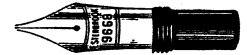

- | | |
|---------------------------------------|--------------------------------|
| No. 9450 <i>Posting 1-2-3</i> ✓ | No. 9788 <i>Shaded Writing</i> |
| No. 9550 <i>Extra Fine</i> | No. 9460 <i>Carbon Copies</i> |
| No. 9128 <i>Extra Fine Flexible</i> ✓ | No. 9461 <i>Carbon Copies</i> |
| No. 9555 <i>Shorthand no. 2</i> | No. 9968 <i>Broad writing</i> |
| No. 9556 <i>Fine writing</i> | No. 9314F <i>Fine Stub</i> |
| No. 9048 <i>Shaded Writing</i> | No. 9314M <i>Medium stub</i> |
| No. 9668 <i>General writing</i> | No. 9314B <i>Broad Stub</i> |

No. 9284 *Signature Stub*

BALL POINTS

Instant starting, smooth writing! King-size refill gives over 4 1/2 miles of dependable writing, never skips, smears or "leathers." Models to match standard and "K" fountain pens and Push Pencils. Choice of extra-fine or medium points, choice of blue or red ink. One-hand operation: push the top to get the point — push again to retract. Point revolves one-quarter turn per retraction — evens wear on the ball socket for longer life. Has no loose springs or parts to fall out.

Choice of models to match any Esterbrook fountain pen or Ball Point. Easy, one-hand operation — just push the top to feel the lead. Feeds 360 sharp new points one after another without reloading. Front "clutch" and guide tube insure against lead breakage and "chattering."

PUSH PENCILS

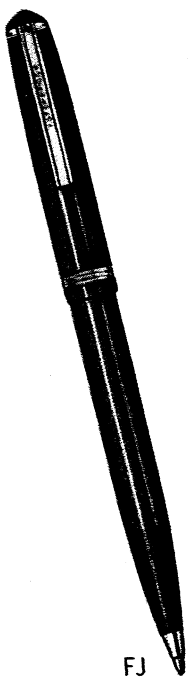

FJ

Matches fountain pen models LJ, J and SJ. Matches Push Pencil models PJ and TTJ. Colors: Red, Blue, Green, Gray, Brown. Black. \$2.50



FK

Matches LK fountain pen and TK Push Pencil. Colors: Midnight, Burgundy, Emerald Green, Royal Blue, Willow Green, Colonial Gray. \$3.75



PJ

Standard size model. Matches fountain pen models LJ, J and SJ. Matches FJ Ball Point. Uses .046" standard lead. Colors: Red, Blue, Green, Gray, Brown, Black. \$2.50



TTJ

Slender, lightweight model. Matches fountain pen models LJ, J and SJ. Matches FJ Ball Point. Uses .036" thin lead. Same colors as Model PJ. \$2.50



TTH

Purse-size pencil matches model CH fountain pen. Uses .036" thin lead. Colors: Aqua, Blue, Peach, Orchid, Yellow, White. \$2.50



TK

Matches LK fountain pen and FK Ball Point. Uses .036" thin lead. Colors: Midnight, Burgundy, Emerald Green, Royal Blue, Willow Green, Colonial Gray. \$4.00

SOLID DURACROME POINTS FOR GENERAL USE 50c			MASTER DURACROME POINTS FOR SPECIAL USE \$1.00		
FINE	Bookkeeping	2550	EXTRA-FINE	9450	Posting 1-2-3
FINE	Bookkeeping	2550		9550	Extra Fine
				9120	Extra Fine Flexible
FINE	Fine writing	2556	FINE	9555	Shorthand
FLEX	Shaded Writing	2048		9556	Fine writing
FINE	Clerical	1554		9048	Shaded Writing
FINE	Shorthand	1555			
FINE	Student	1551	MEDIUM	9660	General writing
FINE	General writing	2060		9740	Shaded Writing
			MANIFOLD	9460	Medium Manifold
				9461	Fine Manifold
			BROAD	9960	Broad writing
FINE	Broad writing	2960			
FINE	Fine Stub	2442	STUB	9314F	Fine Stub
FINE	Fine Stub	2314F		9314M	Medium stub
FINE	Medium stub	2314M		9314B	Broad Stub
FINE	Broad Stub	2314B		9284	Signature Stub
FINE	Signature Stub	2284			

NOW

FOR
COUNTER
OR
DESK

Esterbrook® BALL POINT DESK PEN

At counter or desk, for casual writing, for brief notes or checking, for clean, clear carbon copies — Esterbrook offers a functionally designed holder and a ball point unit of traditional Esterbrook quality.

MODEL FWT* \$2.15

Ball Point Desk Pen. Gracefully tapered, perfectly balanced, ideal for counter or desk use. No ink-smudged fingers — will not blot or smear. Esterbrook Refill Units available at your stationer's.

*Fits all Esterbrook fountain desk pen bases.

No. 212 Ball Point Desk Pen Set \$3.25

Complete with model FWT Ball Point Desk Pen. Base of Nu Black Porcelain with permanent, lustrous finish. Ideal for counter or desk use.

No. 213 (For Public Counter Use) \$3.75

Ball Point Desk Pen Set complete with model FWT Ball Point Desk Pen and 2-foot chain attached to base. Designed for public counter use. Set has adhesive base, which can be adhered to any surface.

Esterbrook Ball Point Desk Pen Refills \$.50

Individually packed and heat-sealed in plastic envelope. Packed 12 Refills in a carton.

Prices shown include F.E. Tax.

FOUNTAIN
PEN
DESK SETS

Enjoy the convenience of fountain pen writing in a desk set! Well-balanced, gracefully tapered desk pens provide easy, comfortable writing. Convenient filling from any ink bottle. Thirty point styles let you "Choose the right point for the way you write... by number."

Ideal for special uses, such as public counter writing and for making clean, clear carbon copies. Fine for casual notes. Permanent, non-transferable ink won't blot or smear. Choice of red or blue ink in long lasting refills.

BALL POINT
DESK SETS



Economical and practical. Uses minimum desk space. Black only. \$3.75. (Model 113, same as above, plus two-foot chain and adhesive backing for permanent installation, \$4.25)

112

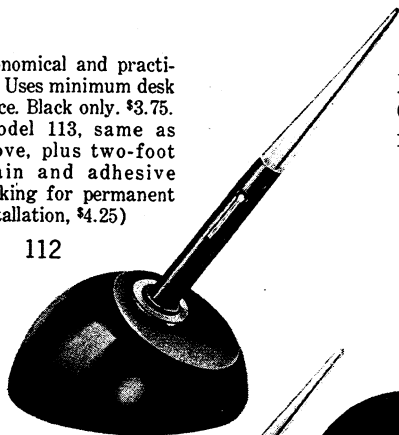

COMMERCIAL SETS

Maximum writing efficiency at minimum cost. Compact, durable porcelain bases with lustrous finish. Ideal for large office installations.

Smartly styled, compact set. Black only. \$3.75. (Model 117, same base style as above, in same colors as Model 116, \$4.25)

114



116

Beautiful decorator colors. Permanent kiln-fired glaze. Colors: Red, Green, Blue, Gray, Brown. Color-matched desk pens. \$4.25

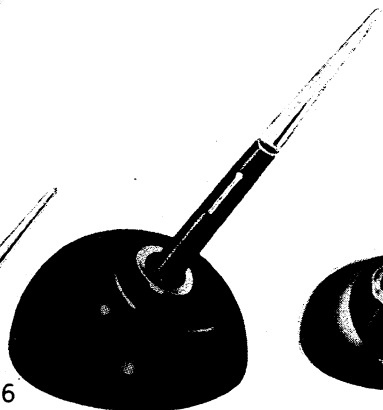

322

Efficient two-pen model. Permits use of two point styles or two ink colors. Black only. \$7.50. (Model 326, same style, in Gray or Green, \$8.50)

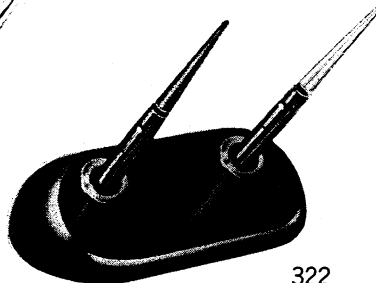

The public counter special! Complete with two-foot chain and adhesive backing for permanent installation. Adheres to any solid surface. Durable porcelain base. \$4.25. (Model 212, same as above, but without chain and adhesive backing, \$3.75)

213

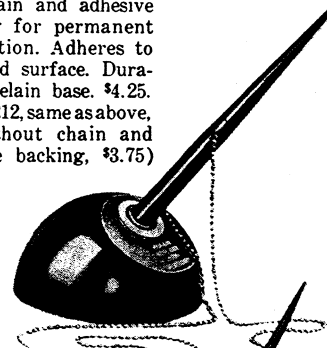

Model FWB pen shown in popular jet glass base. Attractive and functional. \$7.00

2121

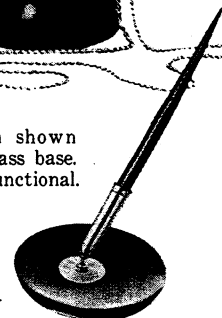

EXECUTIVE SETS

Distinctive additions to any home or office desk. Swivel trumpets keep desk pen within easy reach.

JET GLASS SERIES

Highly polished bases of gleaming jet glass. Three styles: 2110, square; 2111, round; 2112, oval. \$7.95

2110



2111



2112



2140 AZURE

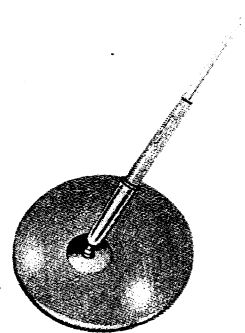

MEDALLION SERIES

Designed for the modern home or office desk. Brilliantly finished ceramic bases in distinctive, continuous curve styling. Decorator colors: Azure Blue, Lime Green, Jet Black with color-matched pens. \$7.95

2230

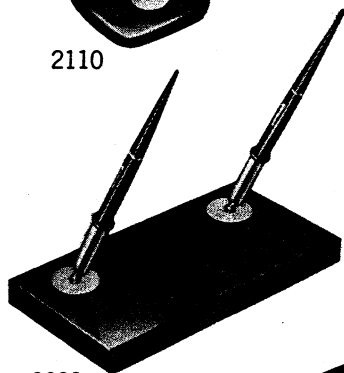

2231

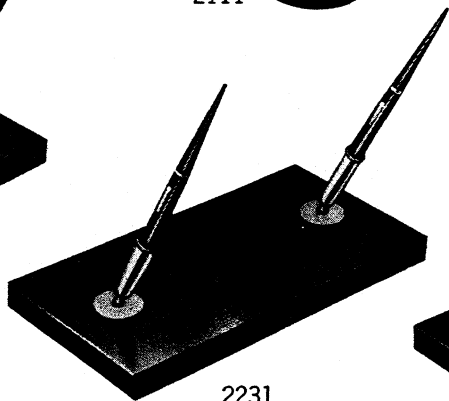

2131

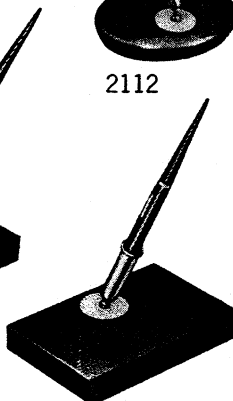

2130



EXECUTIVE CARRARA SERIES

Highest presentation quality. Bases are finest black Carrara glass, ground and polished to flawless perfection.

2130—\$10.00, 2131—\$13.50, 2230—\$22.50, 2231—\$27.50

2140 LIME

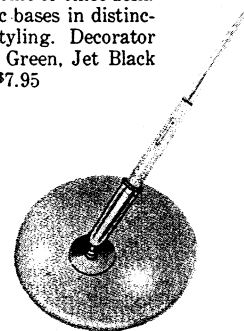

2140 JET

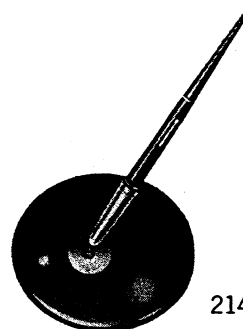

* Model FWB ball point desk pen can be used with any Esterbrook fountain pen desk set

Esterbrook[®]

DESK PEN SETS FOUNTAIN PEN

MODEL W \$2.15*

Conventional, lever fill, tapered desk pen. A precision holder balanced for writing ease. Accommodates any Esterbrook Renew-Point. In colors to match all fountain desk pen bases.

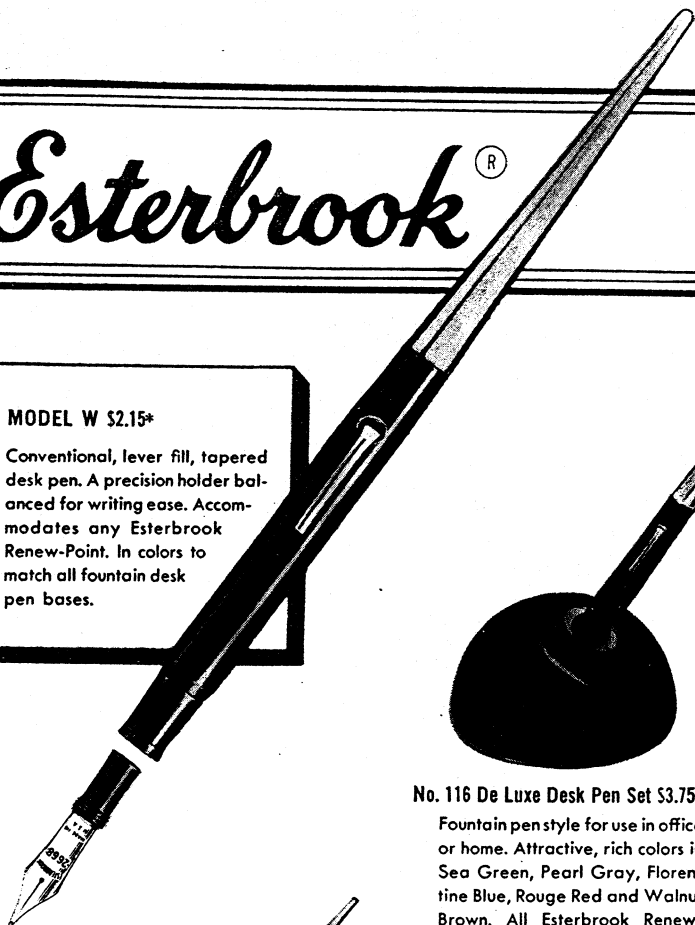

Smartly designed to give the user the utmost in writing pleasure while at his desk. For office or home use. All Esterbrook Renew-Points are interchangeable within these sets.

No. 116 De Luxe Desk Pen Set \$3.75*

Fountain pen style for use in office or home. Attractive, rich colors in Sea Green, Pearl Gray, Florentine Blue, Rouge Red and Walnut Brown. All Esterbrook Renew-Points are interchangeable.

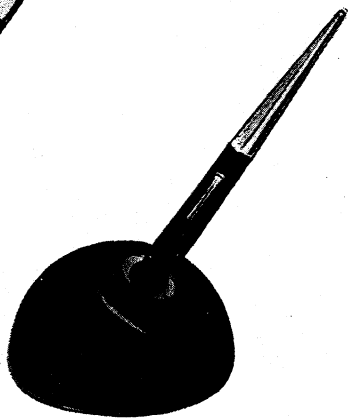

No. 112 Desk Pen Set \$3.25*

Equipped with attractive Renew-Point fountain pen. Your favorite Esterbrook Renew-Point may be used with this holder. Base and holder color, Black.

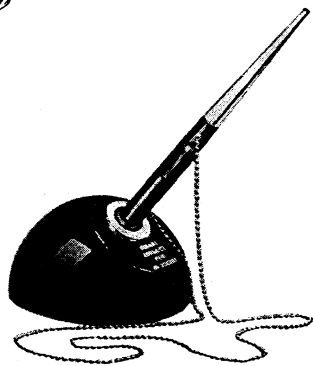
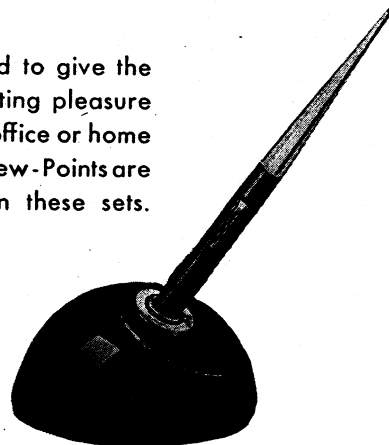

No. 113 (For Public Counter Use) \$3.75*

Single desk pen set complete with two-foot chain attaching base to holder. Base can be securely adhered to any surface.

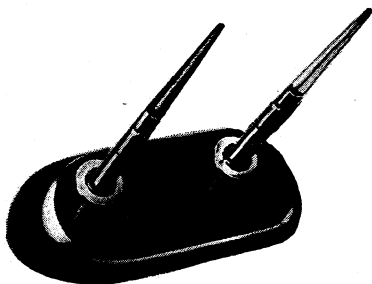

No. 322 Double Desk Pen Set \$6.50*

Equipped with two Esterbrook Renew-Point fountain pens—one for red ink, one for blue ink—or two different styles of points. Base and holder color, Black.

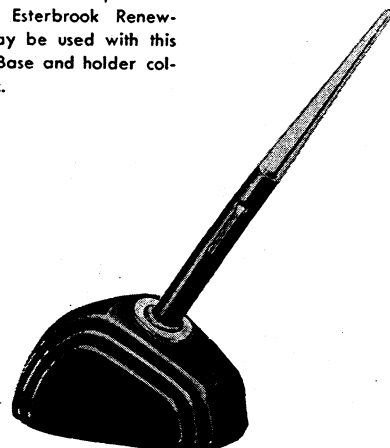

No. 114 Desk Pen Set \$3.25*

Equipped with attractive Renew-Point fountain pen. Your favorite Esterbrook Renew-Point may be used with this holder. Base and holder color, Black.

No. 2111 (ROUND) \$6.50†

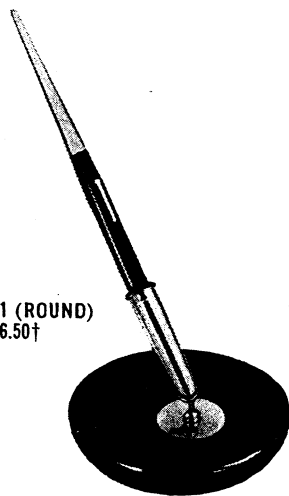

No. 2110 (SQUARE) \$6.50†

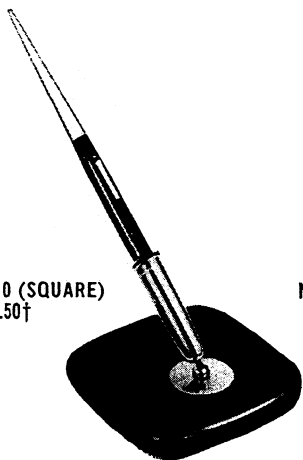

No. 2112 (OVAL) \$6.50†

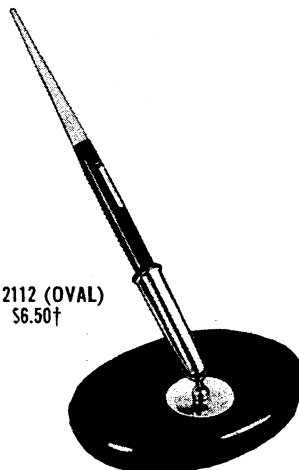

No. 117 De Luxe Desk Pen Set \$3.75*

Fountain pen style for use in office or home. Attractive, rich colors in Sea Green, Pearl Gray, Florentine Blue, Rouge Red, Walnut Brown. All Esterbrook Renew-Points are interchangeable.



Executive-styled Jet Glass Fountain Desk Pen Sets, complete with pen and choice of any Esterbrook Renew-Point. Packed in attractive gift box.

CAPILLARY PEN DESK SETS

World's most popular desk pen set!
Compact, functional design. Base
colors: Green, Gray, Maroon, Black,
Clear. \$4.50

444

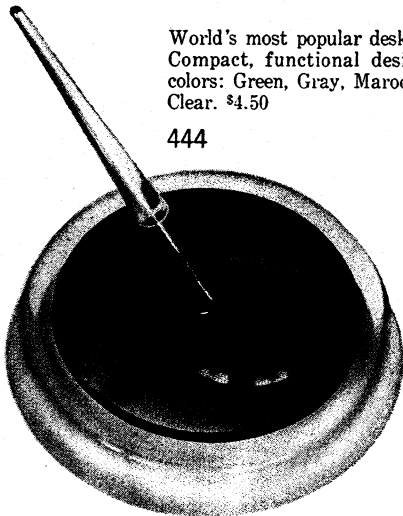

THE PEN

- Always ready to write 300 words or more without dipping.
- Lets you "Choose the right point for the way you write... by number." Use with any Esterbrook point.
- Feeds ink smoothly, evenly.
- Well-balanced for easy, comfortable writing.
- Gives positive protection from ink-stained fingers.

THE BASE

- Giant ink fountain in base holds 40 times more ink than ordinary fountain pens. One filling lasts for months!
- Virtually spill-proof. Ink is locked in base... only the pen can take it out.
- Engineered to eliminate leakage, ink overflow and evaporation.
- Made of ink-proof, odorless materials throughout.
- Fills easily from any ink bottle. Easy to clean.
- Bases available in wide range of styles, materials and prices.

The Pen That Fills Itself... in richly
grained Mexican onyx. \$25.00

4830

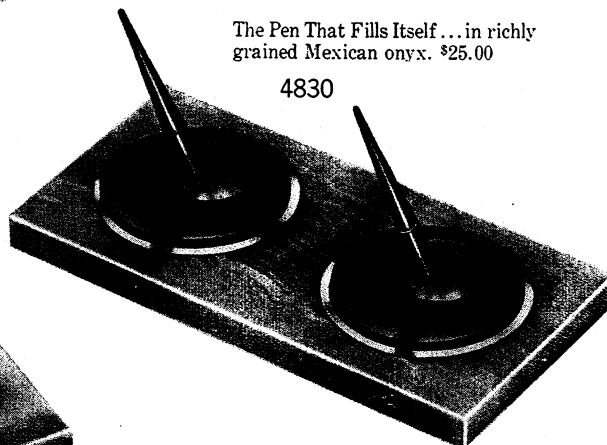

4430

Smart, executive model in Mexican onyx.
\$12.50

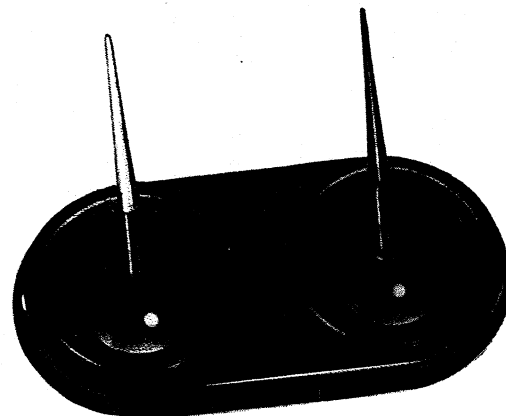

484

Attractive, efficient double style. Permits
use of two ink colors or two point styles.
Same base colors as Model 444. \$9.00

Clean lines, contemporary styling in
handsome Black Carrara. \$12.50. Also
available in double
style, Model 4820.
\$25.00

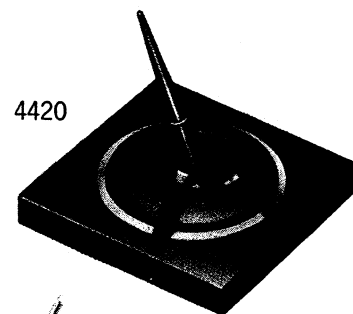

4420

407 DESK SETS

Giant ink fountain holds 2 full ounces of ink;
enough for many months of writing. Pen writes
a full page without dipping, uses any Esterbrook
point. Visible ink supply.

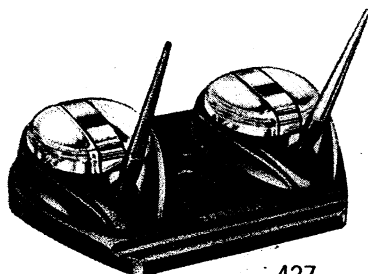

427

Same writing features as Model
407 in two-pen style. Permits use
of two point styles or two ink
colors. Black only. \$8.00

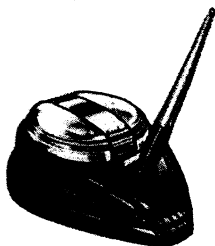

407

Low first cost; economical
in use. Black only. \$4.00.
(Model 408, same as 407
plus two-foot chain for
counter installation. \$4.50)

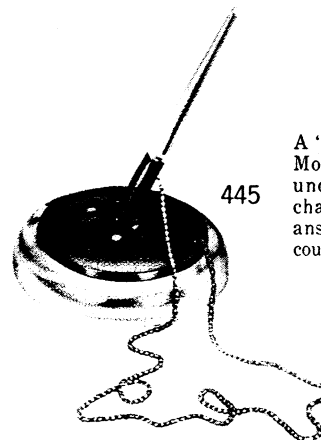

445

A "with-chain" version of
Model 444. Adhesive pad
under base and two-foot
chain make this set the
answer to public writing
counter problems. \$5.00

Esterbrook®

DESK PEN SETS Dipless

MODEL X \$1.65* MODEL XX \$1.65*

Standard size, light weight designed for maximum comfort in constant use. Model XX longer, heavier and larger diameter. Popular as signature pen. Favorite with occasional writers. Both holders feature knurled grip and fit all Esterbrook Renew-Points.

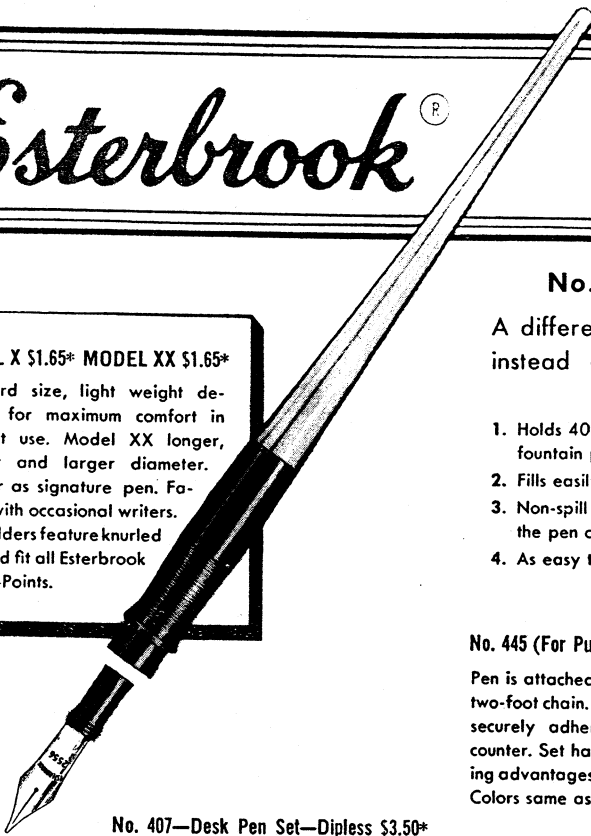

No. 444 WITH THE PEN THAT FILLS ITSELF

A different, better Desk Pen—with the ink fountain in the base instead of in the pen barrel. Perfect for busy office desks.

THE BASE

1. Holds 40 times more ink than ordinary fountain pens.
2. Fills easily from the top.
3. Non-spill . . . ink is locked in base, only the pen can take the ink out.
4. As easy to clean as a cup.

THE PEN

1. Uses any Esterbrook Renew-Point.
2. Cannot leak or flood.
3. Delivers constant, uniform line.
4. No ink-smudged fingers.
5. Writes 300 words and more without dipping.



No. 445 (For Public Counter Use) \$4.50*

Pen is attached to base by two-foot chain. Base can be securely adhered to any counter. Set has same writing advantages as No. 444. Colors same as No. 444.

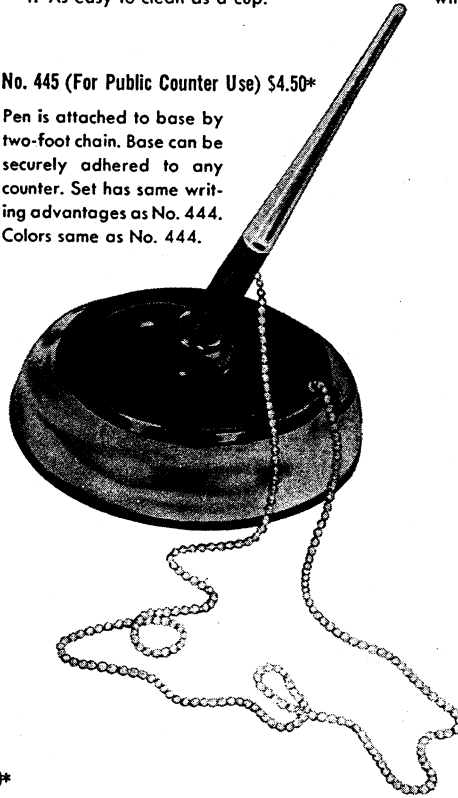

No. 444 \$4.00*

Green Ink-Lock Desk Set. Also available in Black, Gray, Clear and Maroon.

No. 407—Desk Pen Set—Dipless \$3.50*

Inverted bottle holds full 2-oz. bottle of ink—Controlled ink level—Easy to fill. One dip of the pen and you can write 300 words and more. All Esterbrook No. 2000 and 9000 series Renew-Points are interchangeable in these sets. Base and holder color, Black.

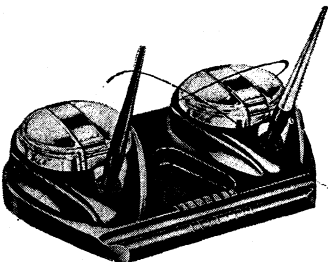
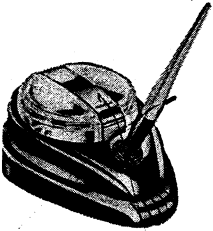

No. 427—Double Desk Pen Set—Dipless \$7.00*

Double model—one well for blue ink, the other for red ink—or two different styles of points. Same writing advantages as No. 407. Base and holder color, Black.

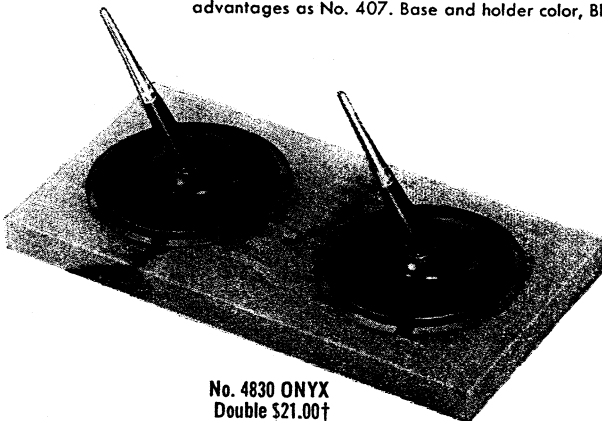

No. 4830 ONYX
Double \$21.00†
4430—Single \$10.50†

No. 484 \$8.00*

Maroon Ink-Lock Double Desk Set. Also available in Black, Gray, Green and Clear.

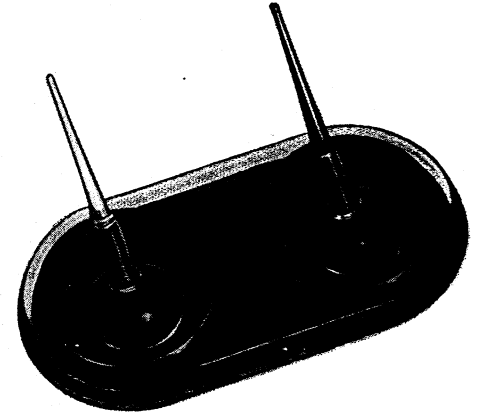

No. 4420 CARRARA
Single \$10.50†
4820—Double \$21.00†

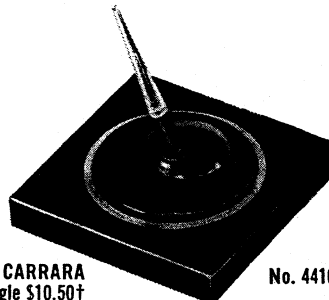

No. 4410 PERMALITE GREEN
Single \$8.00†
4810—Double \$16.00†

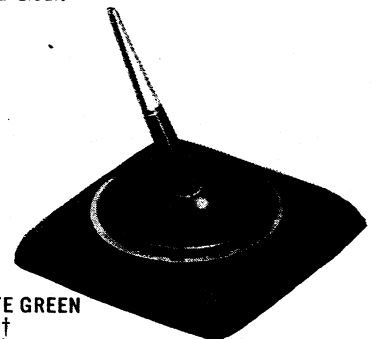

Executive-styled Dipless Desk Pen Sets. Available in single and double models of Onyx, Black Carrara or Permalite (simulated leather). Permalite available in four colors: Maroon, Gray, Green and Brown. Choice of any Esterbrook Renew-Point. Sets have same virtues as Model No. 444.

*Add 50 cents per pen if Master Point is selected

†Deduct 50 cents per pen if Duracrome Point is selected